

J.L.Fisher

Motion Picture &
Television Equipment

MODEL 9 CAMERA DOLLY

OUR LARGEST HYDRAULIC LIFT DOLLY

The Model 9 is our largest camera Dolly. It is a stable, reliable camera platform with a variety of features and accessories. This Dolly is widely known for its use in television production and has provided the industry with a long history of reliable service. A new feature of the Model 9 Dolly is a smoother hydraulic system that includes a dampening valve which cushions the top and bottom of the lift. The Model 9 Dolly is easy to maneuver, dependable, requires low maintenance and continues to meet the needs of professionals in the motion picture, television and video industries.

500 LB (227kg) LIFT BEAM CAPACITY



STEERING MODES

REAR (CONVENTIONAL):

Front wheels are locked, rear wheels can rotate 360°.

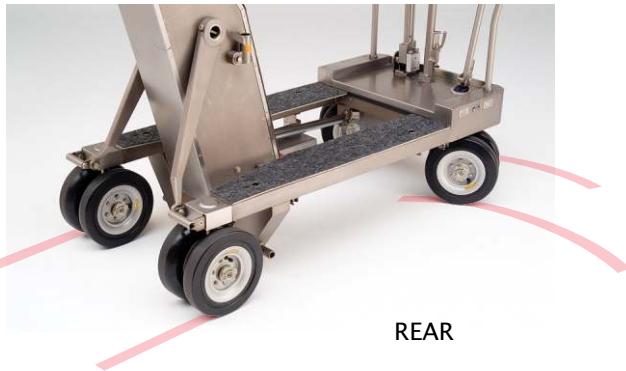

CRAB:

Front and rear wheels can rotate in unison 360°.

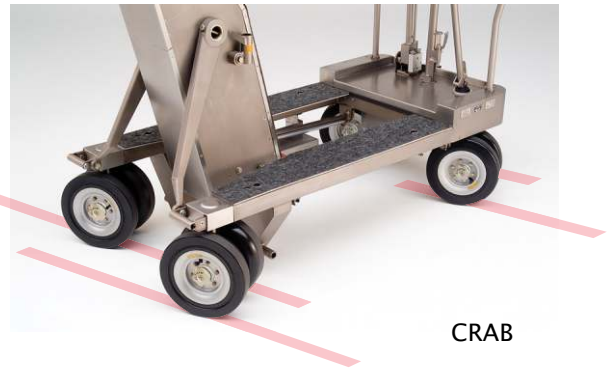

ACCEPTS 90 TO 240 VOLTS AC OR DC TO CHARGE THE HYDRAULIC LIFT SYSTEM IN AS LITTLE AS THREE MINUTES

8 SEAT MOUNT LOCATIONS

4 WAY LEVEL HEAD

REMOVABLE PUSH POSTS

UTILITY HOOKS

CABLE CLIPS ON BEAM

SLIDING, CLOTH COVERED CUSHIONED SEATS WITH ADJUSTABLE HEIGHT

CARPETED STANDING AREAS

SINGLE LEVER POSITIVE LOCKING BRAKE SYSTEM

BATTERY BOX

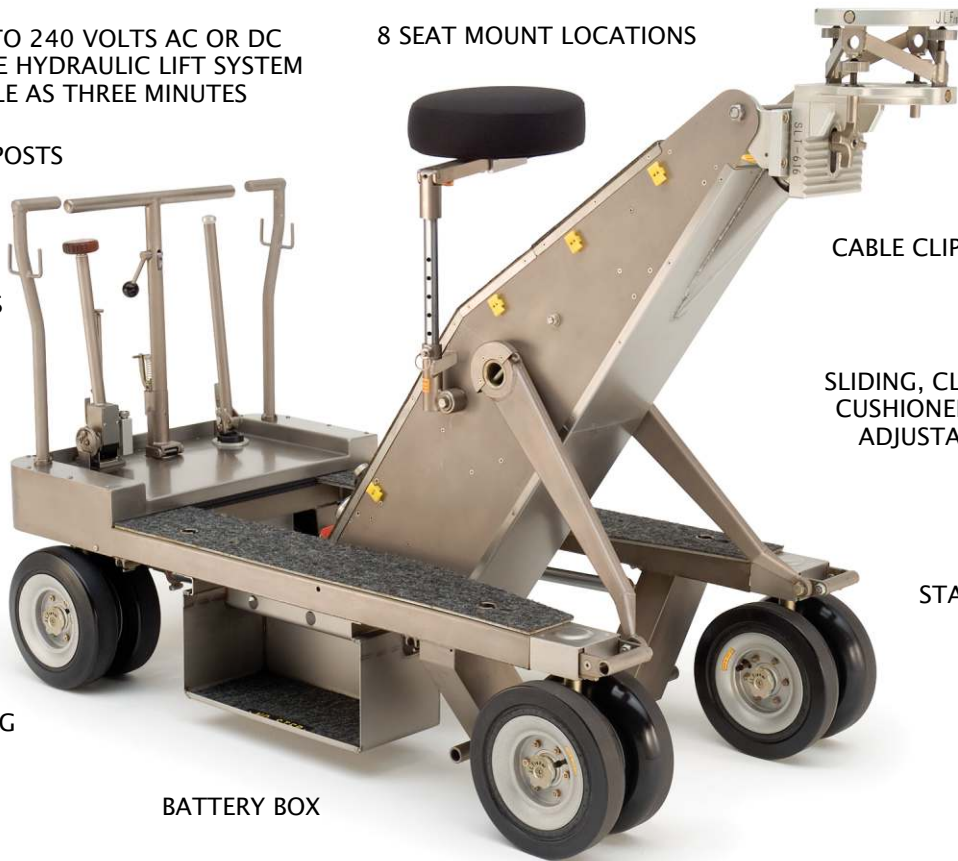

PUSH POSTS DOUBLE AS REAR CARRY HANDLES



POSITIVE LOCKING BRAKES



FULLY ARTICULATED SKATEBOARD WHEELS



MITCHELL MOUNT LEVELING HEAD WITH 4 WAY ADJUSTMENT AND 360° ADJUSTABLE DIAMOND PLATE

FIVE LIFTS PER SYSTEM CHARGE

SELF-BLEEDING HYDRAULIC SYSTEM

500 lb. (227kg) LIFT BEAM CAPACITY

LIFT BEAM POSITION (CUE) INDICATOR

SELF-DAMPENING LIFT BEAM SYSTEM

PNEUMATIC TIRES

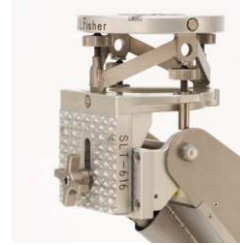

LEVELING HEAD CAN BE REVERSED



SELF CENTERING HYDRAULIC LIFT BEAM CONTROL KNOB WITH SAFETY LOCK

OPTIONAL UP/DOWN LEVER WITH SAFETY LOCK



HYDRAULIC HAND PUMP FOR LOCATION WORK



The Model 9 Dolly has a maximum load capacity of 1200 lbs. (544 kg)



LIFT BEAM (CUE) INDICATOR



Power Requirements: 90 TO 240 VOLTS AC OR DC

STANDARD RENTAL PACKAGE

The Standard Rental Package includes these items:

- 1 SLT 4-way Level Head
- 1 HS Hand Screw (for SLT)
- 2 S Large Seats
- 2 PP Push Posts
- 2 L Low Side Boards
- 2 F Front Boards
- 2 H High Side Boards
- 2 CH Carry Handles
- 1 PC Power Cord
- 1 BPR Knee Bumper
- 2 AWR Allen Wrenches
- 4 FW9 Pneumatic Tires (front)
- 4 RW9 Pneumatic Tires (rear)
- 1 BRN Battery Box

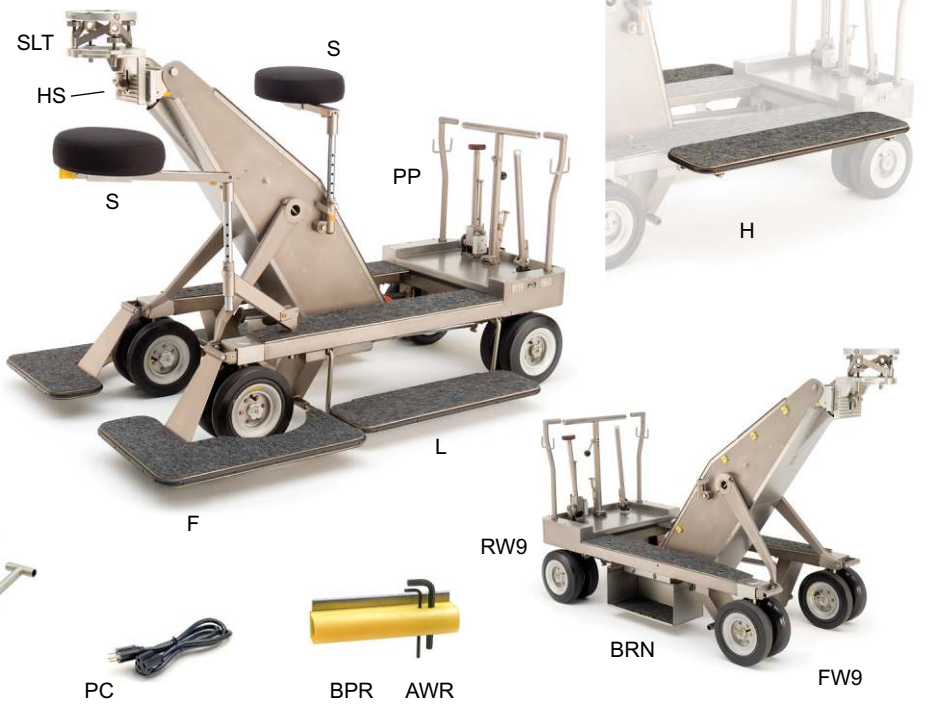

OPTIONAL ACCESSORIES

*Asterisk indicates items are included in the **FULL RENTAL PACKAGE**

Dolly Boards & Platforms

- BS* Beam Step Standing Platform
- DBL* Diving Board, Left
- DBR* Diving Board, Right
- NFB* Front Board Bridge
- FP Front Porch
- PB Push Bar

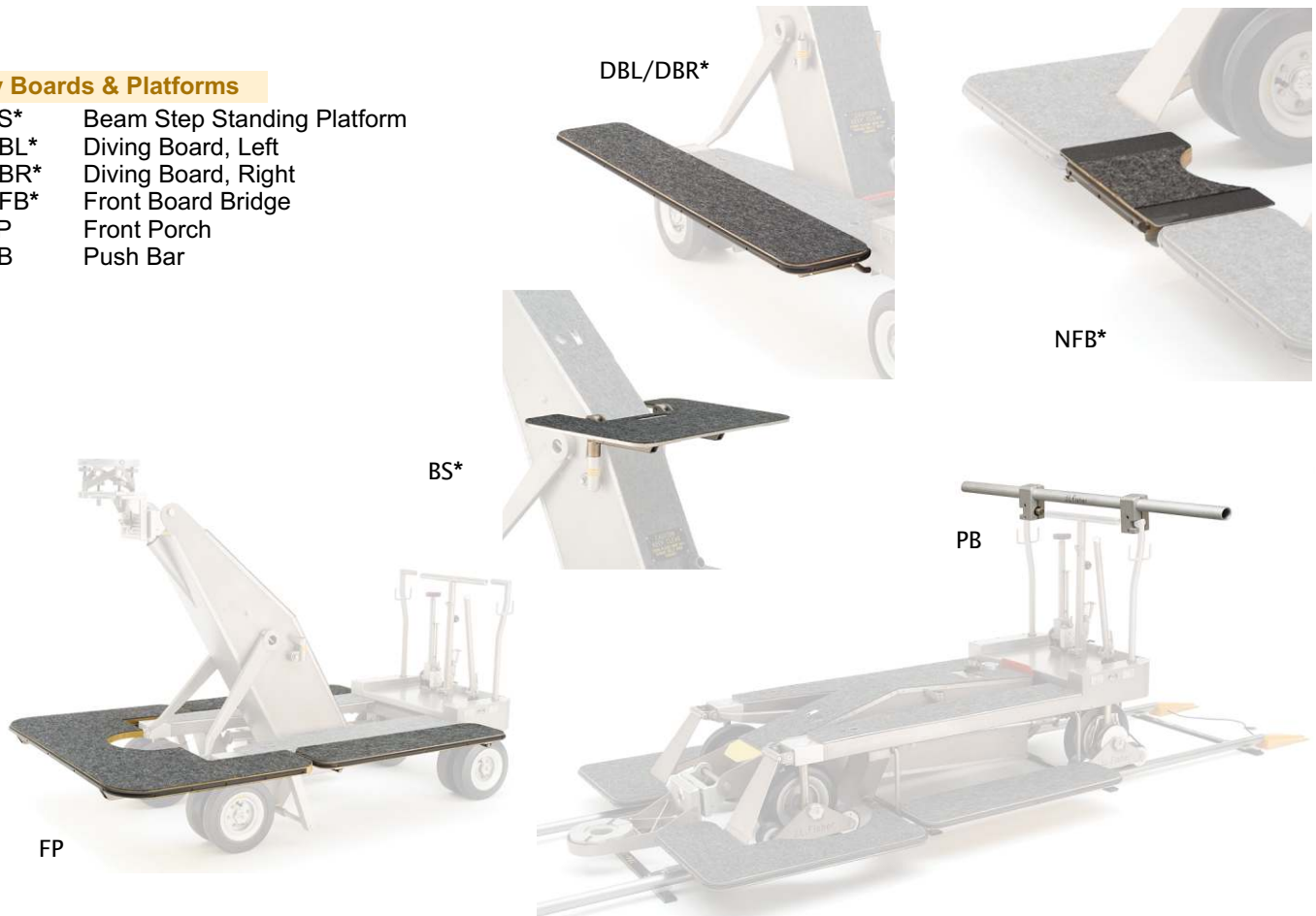

MORE OPTIONAL ACCESSORIES

*Asterisk indicates items are included in the FULL RENTAL PACKAGE

Risers

- R3 Camera Riser, 3" (7.6cm)
- R6* Camera Riser, 6" (15.2cm)
- R12* Camera Riser, 12" (30.5cm)
- R6BA Camera Riser w/ 75mm Ball Adapter, 6" (15.2cm)
- R6BB Camera Riser w/ 100mm Ball Adapter, 6" (15.2cm)
- R6BC Camera Riser w/ 150mm Ball Adapter, 6" (15.2cm)
- R12BA Camera Riser w/ 75mm Ball Adapter, 12" (30.5cm)
- R12BB Camera Riser w/ 100mm Ball Adapter, 12" (30.5cm)
- R12BC Camera Riser w/ 150mm Ball Adapter, 12" (30.5cm)
- RJ12 Heavy Duty Camera Riser, 12" (30.5cm)
- RJ18 Heavy Duty Camera Riser, 18" (45.7cm)
- RJ24 Heavy Duty Camera Riser, 24" (61cm)
- RJ36 Heavy Duty Camera Riser, 36" (91.4cm)

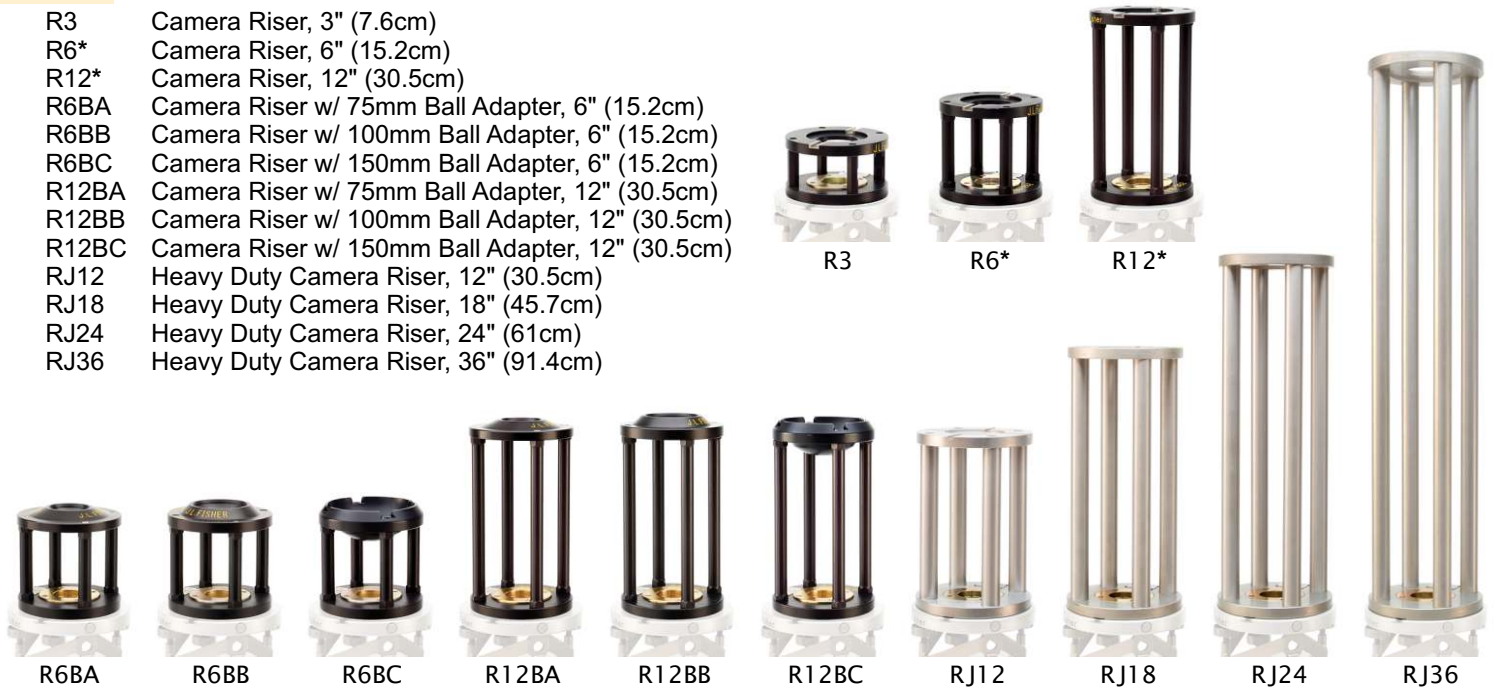

Note: R6, R12, U and TH are also available in Heavy Duty versions

Angle Plate

- AP* 90-Degree Camera Angle Plate



Offsets

- U* Camera Offset, 10" (25.4cm)
- TH* Camera Offset, 24" (61cm)
- RO* Rotating Offset
- ROB Rotating Offset w/ Ball Adapter, 150mm
- ROL Rotating Offset, Low
- ROHL Rotating Offset, High/Low
- ROX Rotating Offset, Long
- ROP Rotating Offset, Pivot

Adapters

- 75A 75mm Ball Adapter
- 100A 100mm Ball Adapter
- 150A 150mm Ball Adapter
- UA Universal Adapter
- HBA Half-Ball Adapter
- MEA Mitchell Euro Adapter
- WAT Waffle Adapter



Low Level Head

- LHN* 4-way Low Level Head

Seat & Seat Accessories

- RS Rotating Seat
- SOH* Seat Offset High
- SOL Seat Offset Low (Includes Seat)
- SOS* Seat Offset Straight
- SSOS Seat Offset Short
- SR6* Seat Riser Adjustable
- BR/MLA Seat w/Backrest & Adapter (for use w/SLT only)



MORE OPTIONAL ACCESSORIES

Crossarms

- CRA1 Cross Arm, 11.5" (29cm) to 19" (48cm) Reach
- CRA2 Cross Arm, 15" (38cm) to 24" (61cm) Reach
- CRA3 Cross Arm, 18" (46cm) to 29" (74cm) Reach
- CRA4 Cross Arm, 23" (58cm) to 36" (91cm) Reach
- CRA6 Cross Arm, 31" (79cm) to 53" (135cm) Reach
- CRA8 Cross Arm, 40" (102cm) to 68" (173cm) Reach
- CRA12 Cross Arm, 54" (137cm) to 100" (254cm) Reach



CRA4

Please refer to the Crossarm Brochure or our web site, www.jffisher.com, for full specifications and options available

Jib Arms

- JIB20 Model 20 Jib Arm, 51.5" (131cm) Reach
- JIB21 Model 21 Jib Arm, 68.5" (174cm) Reach
- JIB22 Model 22 Jib Arm, 99.5" (253cm) Reach
- JIB23 Model 23 Sectional Jib Arm, 21' (6.4m) Reach



JIB21

Please refer to the Jib Arm Brochure or our web site, www.jffisher.com, for full specifications and options available

Utility Cart & Weight Carts



JIB23 - SEVEN SIZES ALL IN ONE BOX

Utility Cart rear view showing section storage

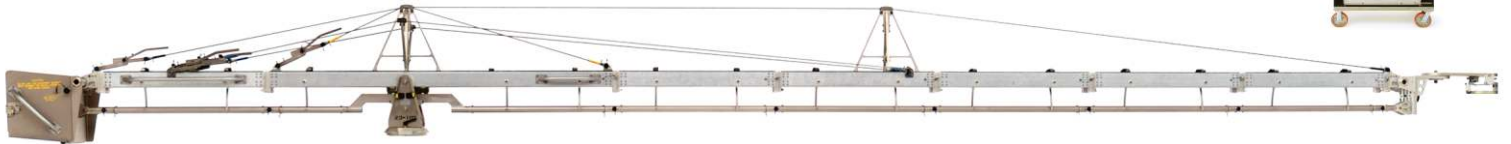

Fluid Heads

- WS2 Weaver/Steadman Fluid Head, 2 Axis
- WS3 Weaver/Steadman Fluid Head, 3 Axis
- V Vector 700 Fluid Head, 2 Axis



WS2

WS3

V

Other Accessories

- BAZ Bazooka (Pneumatic or Sectional)
- CM Center Mount
- CB Cue Board
- HH High Hat
- LA Lamp Adapter
- MRD Monitor Rack
- MLA Mitchell lamp adapter, Junior 1 1/8 in. (MLA)
- PB Push Bar
- SCO Scooter Board
- UDJ Dolly Jack (uses Push Post for handle)

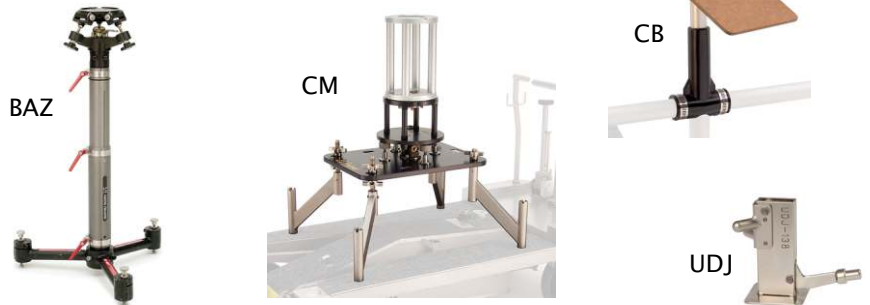

BAZ

CM

CB

UDJ

HH



LA



MRD



MLA



PB



SCO

Wheels & Ice Skates

- SK9 Ice Skates
- SCW9 Soft Compound Wheels
- SW9 Soft Wheels
- TWR* Round Track Adapter
- TWS* Square Track Adapter
- SBWS Skateboard Wheels



SK9

SCW9

SW9

TWR*

TWS*

SBWS

*TWR & TWS for use only on straight track, round or square

All J.L. Fisher track is on 24.5" (62cm) center

Track & Track Accessories

- TR2 Round Straight Track, 2' (.61m)
- TR3 Round Straight Track, 3' (.91m)
- TR4 Round Straight Track, 4' (1.2m)
- TR Round Straight Track, 8' (2.4m)
- TR10 Round Straight Track, 10' (3m)
- CR10 Round Curved Track, 10' (3m) Dia.
- CR Round Curved Track, 20' (6m) Dia.
- STR2 Square Straight Track, 2' (.61m)
- STR3 Square Straight Track, 3' (.91m)
- STR4 Square Straight Track, 4' (1.2m)
- STR Square Straight Track, 8' (2.4m)
- STR10 Square Straight Track, 10' (3m)
- STR16 Square Straight Track, 16' (4.9m)
- STR20 Square Straight Track, 20' (6m)
- CS1 Square Curved Track, 10' (3m) Dia.
- CS2 Square Curved Track, 20' (6m) Dia.
- CS3 Square Curved Track, 30' (9.1m) Dia.
- CS7 Square Curved Track, 70' (21.3m) Dia.
- RMPR Track Ramp For Round Track
- RMP Track Ramp For Square Track
- WED Track Wedges
- TB Track Buckle



1.5"
(3.8cm)
Dia. 

1.5"
(3.8cm)
Sq. 

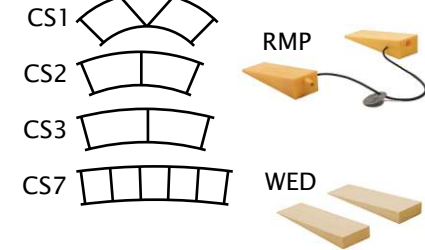
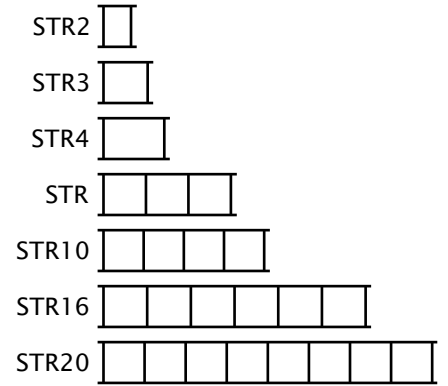
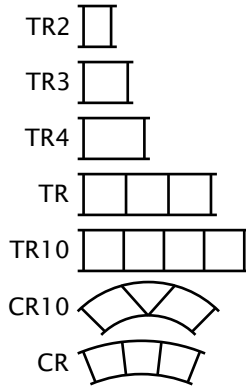

Model 9 Dolly shown with Skateboard Wheels (SBWS) on Round Curved Track (CR1)



Patent Pending

NEW FULLY ARTICULATED SKATEBOARD WHEELS

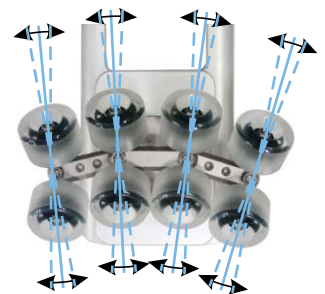

EACH SET OF 2 WHEELS (TRUCK) CAN SWIVEL INDEPENDENTLY

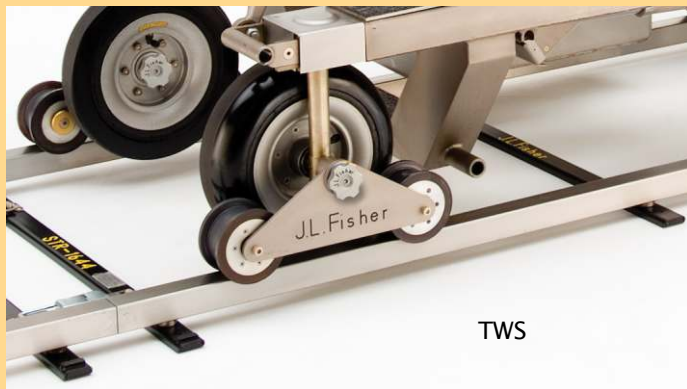

TWS



TWR

TRACK ADAPTERS ARE AVAILABLE FOR BOTH ROUND AND SQUARE STRAIGHT TRACK

TWS* AND TWR* ARE THE ONLY TRACK WHEELS IN THE WORLD WITH POSITIVE LOCKING BRAKES

Maximum Lift Beam Elevation	62 in. (157 cm)
Minimum Elevation (standard head)	12.5 in. (31.8 cm)
Minimum Elevation (low level head)	3.2 in. (8.1 cm)
Vertical Beam Travel	47 in. (119 cm)
Lift Beam Capacity	500 pounds (227 kg)
Lifts per System Charge	5
Length	68.5 in. (174 cm)
Width	30.25 in. 77 cm)
Height (operating)	36.625 in. (93 cm)
Height (folded)	19.5 in. (50 cm)
Height (center mount, before riser)	36.625 in. (93 cm)
Minimum Turn Radius (conventional steering)	51.375 in. (130.5 cm)
Maximum Dolly Load Capacity	1200 pounds (544 kg)
Carrying Weight	445 pounds (202 kg)
Crated Size	75 in. (191 cm) L x 35 in. (89 cm) W x 35 in. (89 cm) H
Crated Weight	802 pounds (364 kg) (standard package)

Note: Due to variables such as adjustments and choice of risers, wheels, etc., these dimensions are approximate.



FOLDING CONTROLS

DIMENSIONS

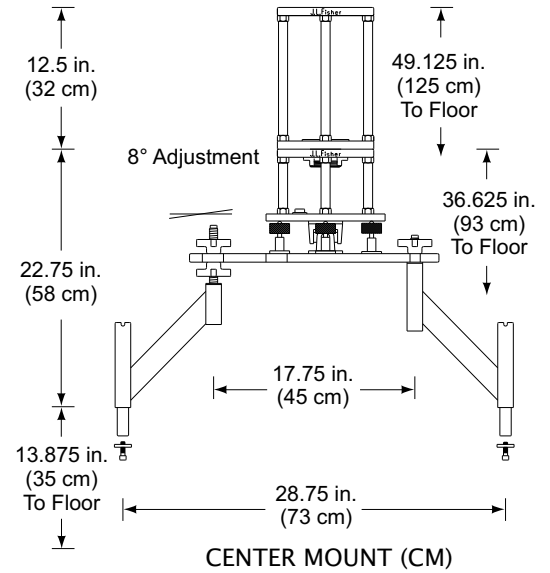
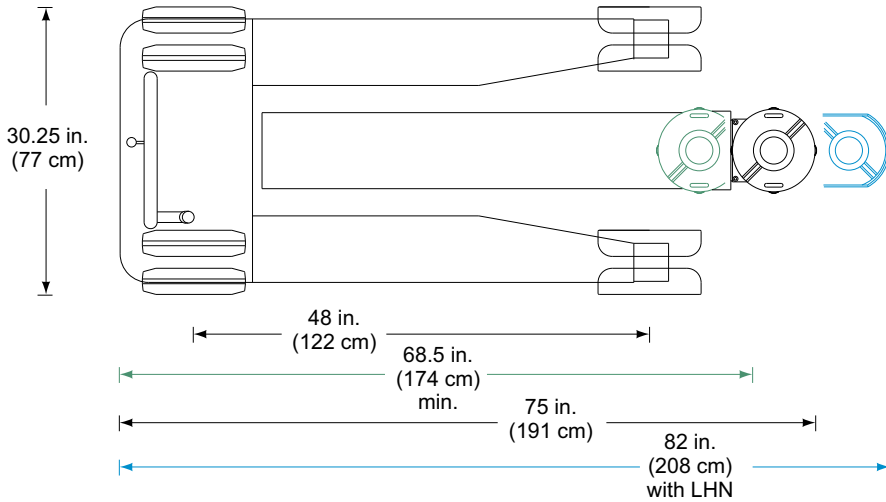

CENTER MOUNT (CM)

The Center Mount (CM), supports jib arms, lightweight camera booms and counterbalanced camera cranes. The Center Mount has thumbscrews for four-way leveling adjustment and a leveling indicator. Easily installed, the Center Mount has a standard Mitchell mount and comes with a heavy duty 12-inch Riser (R12).

The maximum gross load capacity is 1200 pounds (544 kg). Center Mount is not for supporting personnel or personnel carrying cranes.

MODEL 9 DOLLY

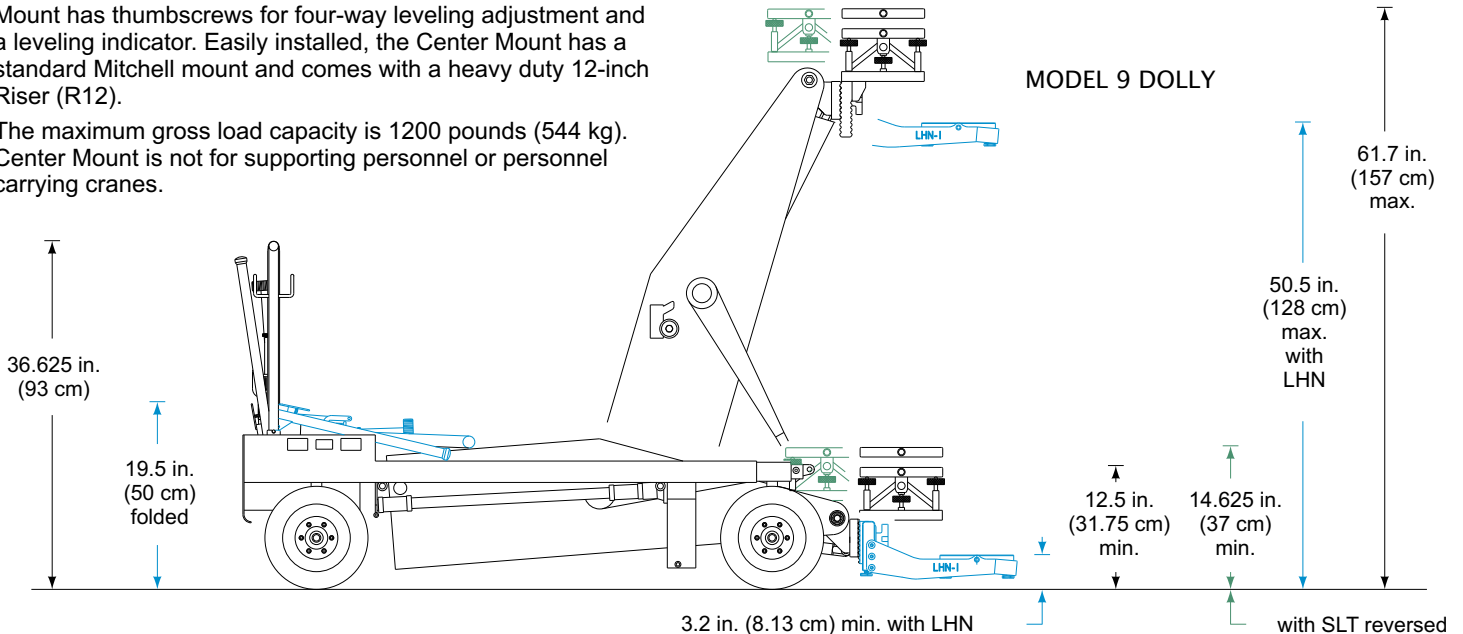

J.L. FISHER PRODUCTS ARE PROUDLY MADE IN BURBANK, CALIFORNIA U.S.A.

J.L. Fisher, Inc. Motion Picture & Television Equipment
 1000 W. Isabel Street, Burbank, CA 91506 U.S.A.
 Tel: (818) 846-8366 / Fax: (818) 846-8699
 Web: www.jlfisher.com e-mail: info@jlfisher.com

J.L. Fisher, GmbH Emil-Hoffmann-Str. 55-59 50996 Köln, Germany
 Tel: +49 2236 3922 0 Fax: +49 2236 3922 12
 Web: www.jlfisher.de e-mail: info@jlfisher.de